

PNEUMATIC RECOVERY SYSTEM FOR ABRASIVE BLAST BOOTHS



MRS200-MSW1200



MRS500

TABLE OF CONTENTS

	Page
INTRODUCTION	2,3
DEFINITION OF TERMS USED IN THIS MANUAL.....	4
SYSTEM OVERVIEW	5
PNEUMATIC RECOVERY SYSTEM	6 to 9
PRESSURE VESSEL.....	10, 11
TROUBLESHOOTING	12, 13
ABRASIVE MEDIA RECOVERY SYSTEM.....	14, 16
HMI	17
MRS STARTING PROCEDURE.....	18
HMI INTERFACE	19 to 22
MAINTENANCE	23
BOOTH ENCLOSURE	24, 25
FLOOR HOPPER.....	26
DCM200 DUST COLLECTOR.....	27, 28
RECYCLER DETAIL	29
UNITS - PARTS DETAILS	30
OPTION : SWITCH GATE FOR FLOOR HOPPER (PNEUMATIC)	31
DCM200 DUST COLLECTOR PARTS DETAILS.....	32, 33
SAFETY EQUIPMENT	34
AIR BREATHING - PROTECTIVE EQUIPMENT FOR THE OPERATOR	35 to 39
BLAST SUITS	40
ISTBLAST LIMITED WARRANTY	41
ISTBLAST WARRANTY REGISTRATION	42
INFORMATION- TECHNICAL ASSISTANCE	43
ABOUT THE COMPANY	44

INTRODUCTION

Welcome to the ISTblast family of sandblasting products. This booklet contains helpful information and acquaints you with the operation and maintenance of your equipment. Please read carefully and follow our recommendations to assure trouble free operation. If you have any questions, please do not hesitate to contact your distributor or our technical service.

The products described in this manual, and the information relating to those products, is intended for knowledgeable, experienced users of abrasive blasting equipment.

No representation is intended or made as to the suitability of the products described herein for any particular purpose or application. No representations are intended or made as to the efficiency, production rate, or the useful life of the products described herein. Any estimate regarding production rates or production finishes are the responsibility of the user and must be derived solely from the user's experience and expertise, and must not be based on information in this manual.

The products described in this manual may be combined by the user in a variety of ways for purposes determined solely by the user. No representations are intended or made as to the suitability or engineering balance of the combination of products determined by the user in his selection, nor as to the compliance with regulations or standard practice of such combinations of components or products.

It is the responsibility of the knowledgeable, experienced users of the products mentioned in this manual to familiarize themselves with the appropriate laws, regulations and safe practices that apply to these products, equipment that is connected to these products and materials that may be used with these products.

It is the responsibility of the user to insure that proper training of operators has been performed and a safe work environment is provided.

Our company is proud to provide a variety of products to the abrasive blasting industry, and we have confidence that the professionals in our industry will utilize their knowledge and expertise in the safe efficient use of these products.

DEFINITION OF TERMS USED IN THIS MANUAL

Abrasive (also known as “media”): granular material used for blasting a surface.

Blow down (also known as “depressurize”): to expulse air automatically or manually from a pressurized vessel.

Control Handle: mandatory remote-control device used to start and stop the blaster.

Depressurize (also known as “blow down”): to expulse air automatically or manually from a pressurized vessel.

Pressure Hold System (also known as “manual blow-down system”): blasting system in which the pressure vessel stays pressurized when the control handle is released.

Pressure Release System (also known as “automatic blow-down system”): blasting system in which the pressure vessel is automatically depressurized when the control handle is released.

Pressure Vessel: enclosed section of the blaster filled with pressurized air and abrasive during blasting operations.

Pressurize: to fill the pressure vessel with compressed air.

Properly Trained Person: a person who has successfully passed a training course in sandblasting pertaining mainly to the safe operation of stationary or portable Abrasive Blasters with capacities ranging from 1.5 ft³ to 6.5 ft³ and who has read this entire manual and understands it.

Silica : hazardous substance found in many naturally occurring abrasives. Dust produced by blasting with abrasives containing silica can cause respiratory diseases.

NOTE: Abrasives containing silica must NEVER be used in any blasting situation. Even if respiratory protective equipment is used, the resulting dust can cause respiratory disease.

SAFETY SYMBOLS

The safety symbols below are designed to ensure the safety and protection of the Abrasive Blaster operator and of anyone else nearby. The explanations provided apply to sandblasting equipment.



OR

WARNING

WARNING :This symbol indicates a potentially dangerous situation that could result in serious injury or death if the instructions related to the symbol are not carried out. Throughout the manual, this warning triangle will appear to denote instructions requiring special attention.



OR

DANGER

DANGER : This symbol indicates a potentially dangerous situation that WILL result in serious injury or death if the instructions related to the symbol are not carried out. Throughout the manual, this warning triangle will appear to denote instructions requiring special attention.



SYSTEM OVERVIEW

PNEUMATIC RECOVERY SYSTEMS - HOW IT WORKS

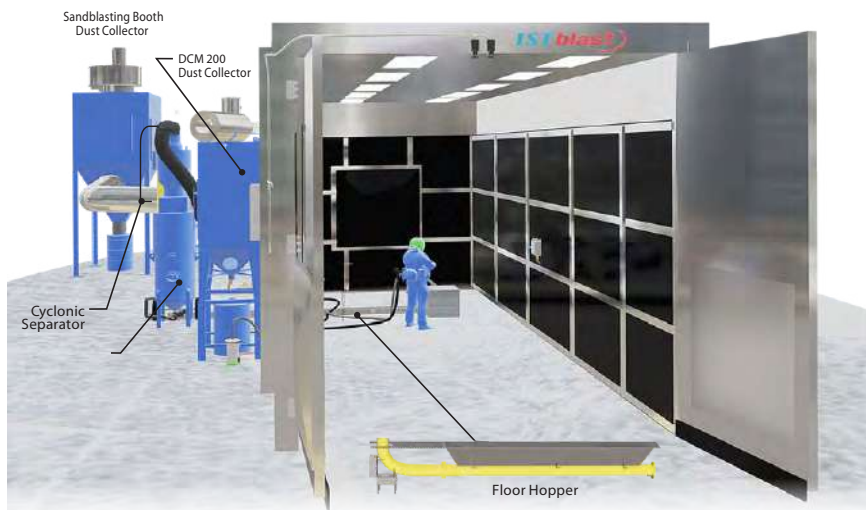

MRS200

MRS200 Pneumatic Floor Recovery System is an efficient and inexpensive solution for recovering used abrasive with minimal effort from the operator. This system is equipped with a high-efficiency impeller dust collector (DCM200), it can handle all major light-to-heavy abrasives available in the market and it offers various floor hoppers layouts. Urethane pneumatic duct system.

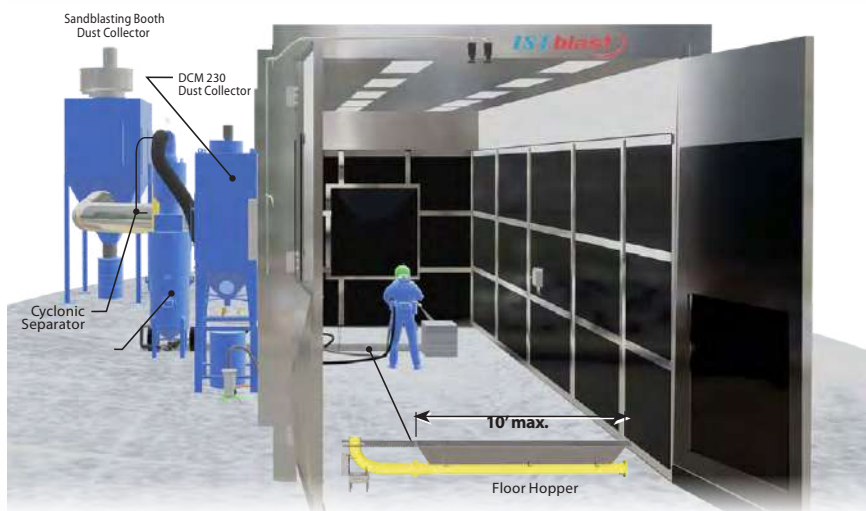

MSW1200

MSW1200 Pneumatic Floor Recovery System is a very affordable solution with limitations in regards to how long the recovery hoppers can be (max. 10 feet) and that can only handle light media (heavy media like steel grit cannot be vacuumed). Urethane pneumatic duct system available.



MRS500

MRS500 Vacuum Recovery System is an inexpensive and easy-to-implement solution that is ideal for collecting residual abrasive from large tanks and hard-to-spill reservoirs. This system uses no floor hopper which requires less care and maintenance.

MULTI PIT SYSTEM WITH GATE VALVE (OVER 3 PITS)

Able to vacuum ONE pit at a time

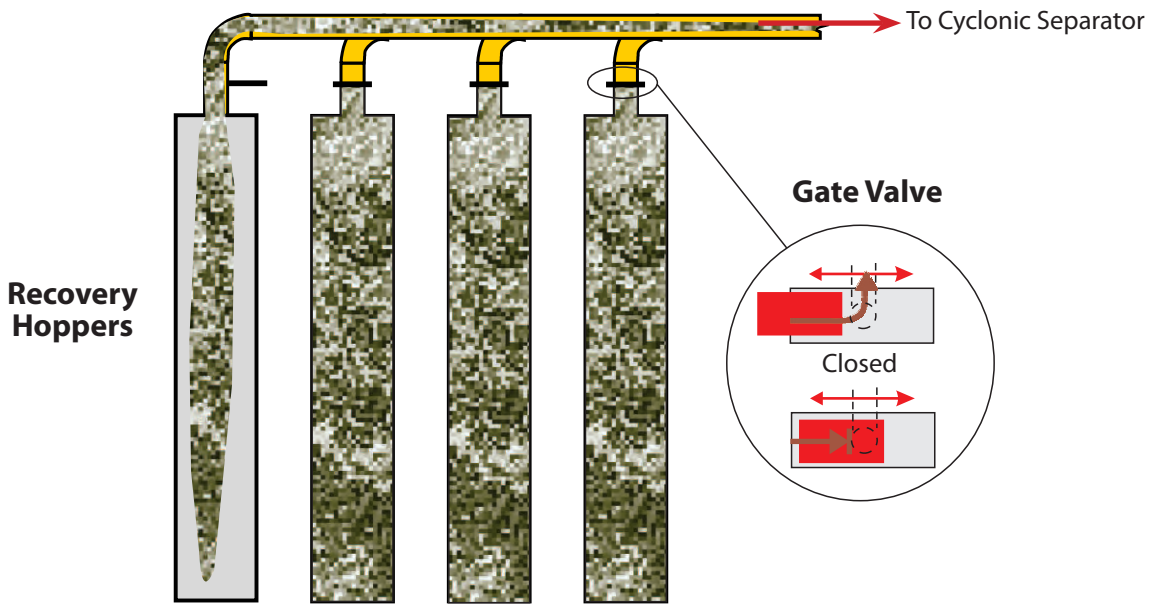

MULTI PIT SYSTEM WITH SELECTION VALVE (UP TO 3 PITS)

Able to vacuum one pit at the time

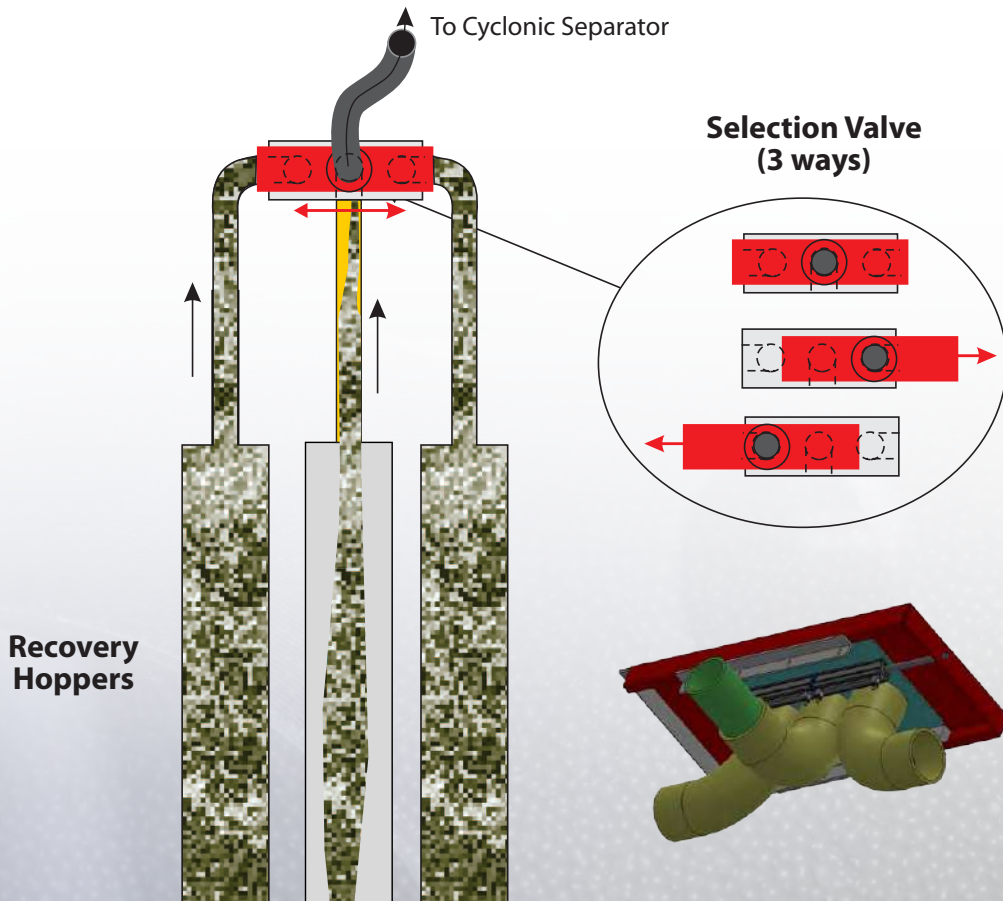

SANDBLAST BOOTH STRUCTURE - AIR CIRCULATION

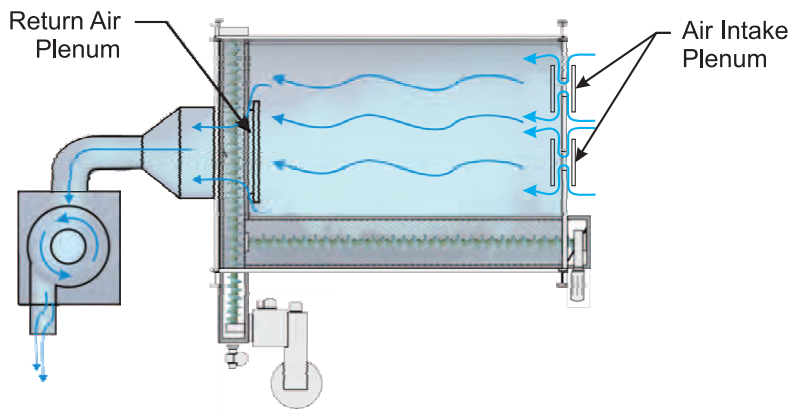

The suction fan, through the dust collector and conduit network, creates a negative pressure of 1/2 "w.g. (Nominal) at one end of the blowing room. This causes the outside air to be sucked through the air inlets at the opposite end of the chamber and generates a cross-flow airflow. The exhaust outlet is diverted to allow only the transport of dust-laden air. The inputs and outputs are proportionally sized to ensure adequate volume and airflows.

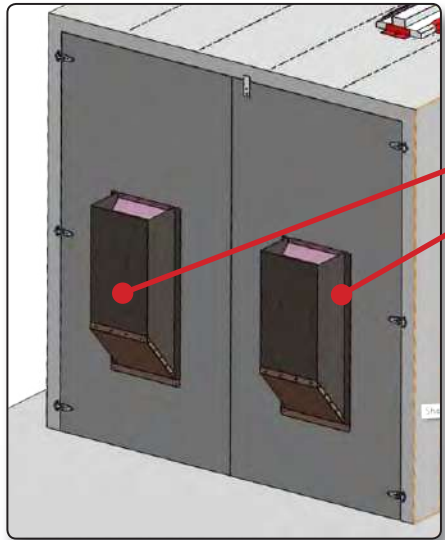

INLET PLENUMS

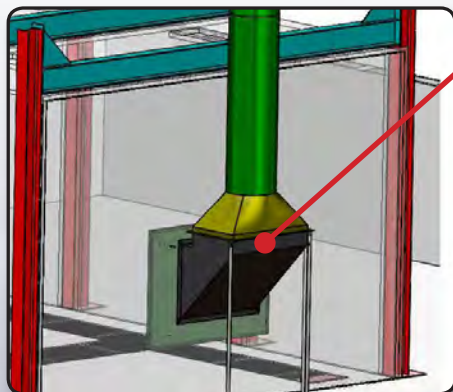

SOLID BACK SANDBLAST BOOTH

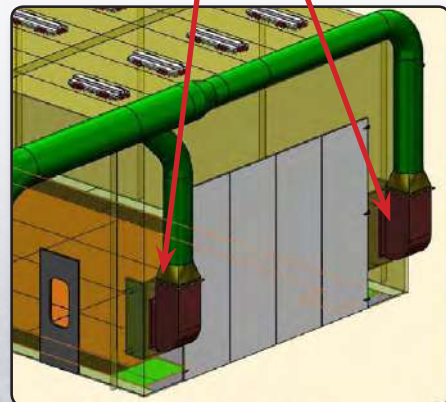

DRIVE THROUGH SANDBLAST BOOTH

OUTLET PLENUMS

REMOTE CONTROL BOXE FOR PRESSURIZATION/DEPRESSURIZATION & BLAST ON/AIR
(LOCATED INSIDE THE SANDBLAST BOOTH)

A PRESSURIZED/DEPRESSURIZED VESSEL SWITCH

The depressurization switch located inside the blast booth allows the operator to fill up its pressure pot without the hassle of leaving the booth and taking off the safety equipment.

This switch controls the AV-176 Combo Air Valve to release the pressure inside the blast pot, allowing the plunger to fall and let the blast media contained into the recovery hopper to fill up the pot.

B BLAST ON/AIR ONLY SWITCH

A pneumatic cut-off switch is provided to turn your blast hose into a powerful air blower producing high velocity compressed air to blow dust off of the workpiece and to clean the floor by blowing abrasive media remains towards the nearest floor recovery hopper. This switch controls the opening and closing of the abrasive metering valve.

When sandblasting is completed, the operator simply places the switch to the "AIR ONLY" position, stopping the flow of abrasive. The air valve remains open so that only high-speed compressed air flows through the nozzle.

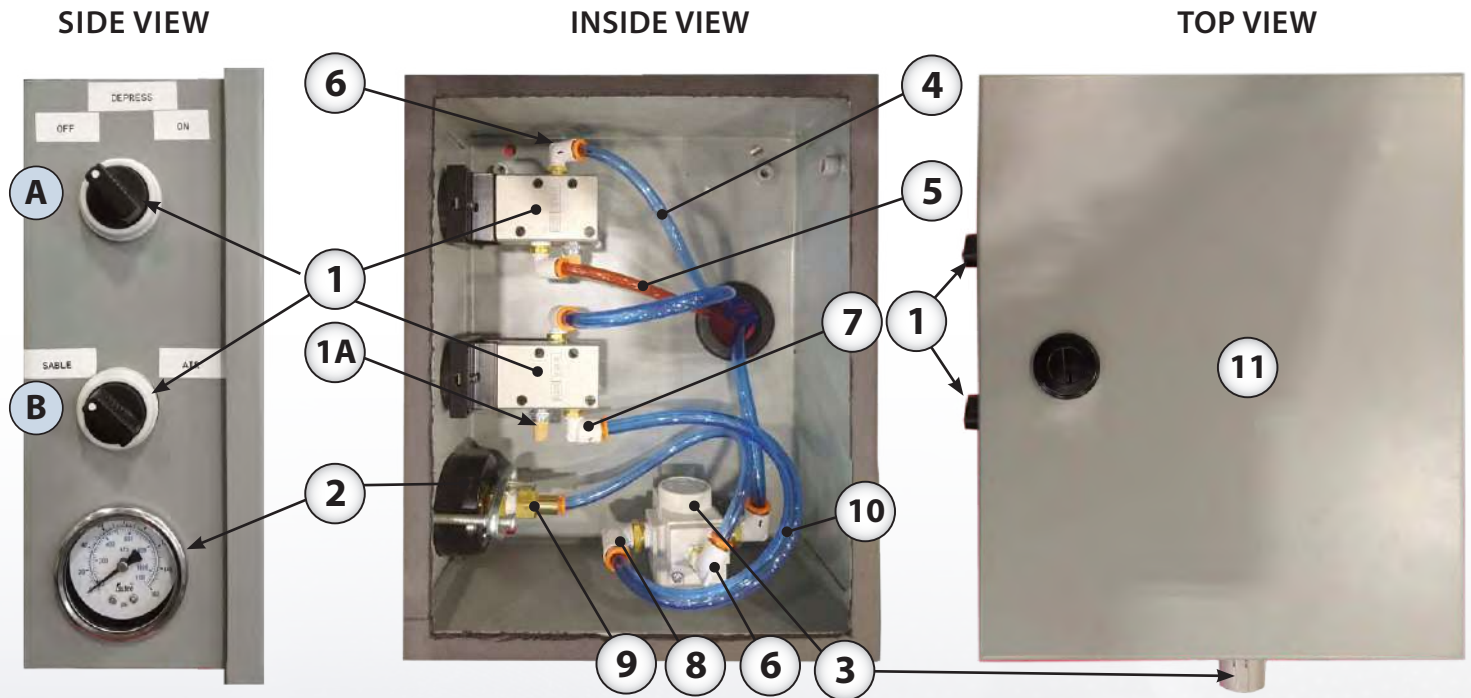

ID	Part #	Description
1	920062	PNEUMATIC SWITCH
1A	608284	MUFFLER
2	740013	1/8" PRESSURE GAUGE
3	608015	1/4" PRESSURE REGULATOR
4	324571	1/4" BLUE POLYESTER TUBE
5	324586	1/4" RED POLYESTER TUBE

ID	Part #	Description
6	324561	90° 1/8" MTP - 1/4" T. PUSH-IN FITTING
7	740009	90° 1/8" MTP - 5/16" T. PUSH-IN FITTING
8	908815	90° 1/4" MTP - 5/16" T. PUSH-IN FITTING
9	324572	1/8" MTP - 1/4" T. PUSH-IN FITTING
10	919584	5/16" BLUE POLYESTER TUBE
11	776130	10" H x 8" L x 4" D JUNCTION BOX

PRESSURE VESSEL - ABRASIVE BLAST LINE



SANDBLAST HOSE

The sandblast hose, which transmits compressed air and media to the blast nozzle, has an internal diameter of 1¼" and an outside diameter of 2 5/32". It weighs 60 pounds for each 50' length. The hose is rated for a working pressure of 175 psig. The hose fitting is ¼" thick, rubber impregnated with carbon black for static dissipation. It is equipped with quick and light aluminum couplings that mount outside and incorporate self-locking safety wires. Fifty (50) feet of sandblast hose and control lines are supplied with each blasting machine. An optional 12 ½" "whip" hose is available at the last section to provide the user with more flexibility and less weight to carry on his back.



SANDBLAST NOZZLE

A double venturi nozzle will be supplied with the sandblasting machine. The nozzles are made of the highest quality materials and designed for a long service life. The nozzle is connected to the sandblast hose with an externally mounted nylon nozzle holder.



OPERATOR REMOTE CONTROLS

The remote controls are pneumatic type, and include a normally closed inlet valve and a normally open outlet valve. The air pressure opens the inlet valve and closes the outlet valve to begin the sanding process. In the event of loss of air pressure on the valves, the springs return the valves to their normal position.

If your sandblast hose is 75 feet or more, the remote control should be electric.

ABOUT THE REMOTE CONTROL SYSTEMS

An electric or pneumatic remote control system (also called "Deadman") must always be used with a sandblasting pot to start and stop blasting.



Electrical: On the sandblasting pot, the remote control handle must be connected to the female socket with rotating latch of the blasting pot. A 12V DC power source (12V battery or optional 120 V AC to 12 V DC converter) must be connected to the male latch connector.



Pneumatic: The dual remote control hose must be connected to the blasting pot using supplied threaded or quick disconnect couplings. The use of pneumatic remote control systems is not recommended with sandblast hoses over 75 feet.

PRESSURE VESSEL - CONTROL VALVES

ABRASIVE METERING VALVES



AR7+A7 MEDIA METERING VALVE ASS'Y

The AR7 is a normally-closed abrasive metering valve can control the flow of abrasive that falls into the blast stream by the use of a crank. The pneumatic actuating function is controlled by the A7 actuator separately. Usually closed, the A7 actuator opens the orifice and let the blast media flow through when the blast flow is activated by the operator.

AIR VALVES



AV-176 COMBO VALVE

The AV-176 valve is a one-piece combination inlet and outlet valve utilized to control compressed air supply into and out of the blast pot.

A single piston assembly is utilized to both open and close the valve's inlet and outlet sections.



AV-186 AIR VALVE

The AV-186 is a diaphragm air valve that controls the air flow of the jet stream when the vessel is pressurized. By default, this valve is closed.

When the operator activates the remote control handle, the AV-186 Air Valve opens and let the compressed air flow through the jet stream, where it mixes up with the media and then propels it at high velocity on the workpiece.

FOR PARTS DETAILS ON VALVES, SEE SANDBLASTING PRESSURE POT INSTRUCTION MANUAL.



CHECKING INSTALLATION

1. Check motor rotation on dust collectors as per arrow indicators placed on each fan.
2. Check that the emergency pull and door security options work properly.
3. Check that the pulse controller for the blast room dust collector activates solenoides on pulsation system (see manual DCM 2,000-50,000).
4. Check that all pipe and hose connections are tightly fastened and air tight.
5. Check that all electrical box covers are securely installed.
6. Check that the dust drum (option) under the dust collector is sitting firmly and is center.
7. Start the dust collector.

TROUBLESHOOTING

TYPE OF FAILURE	POSSIBLE CAUSE	SOLUTION
The fan does not start	<ul style="list-style-type: none"> Deficient power source 	<ul style="list-style-type: none"> Check fuses without circuit
The abrasive is not vacuumed and returned to the storage hopper	<ul style="list-style-type: none"> Bad electrical connection 	<ul style="list-style-type: none"> Check the the fan rotation
	<ul style="list-style-type: none"> Clogging in recovery system 	<ul style="list-style-type: none"> Check the injectors of the recovery pit and clean any obstruction Clean any obstruction in the bend at the outlet of the recovery pit
	<ul style="list-style-type: none"> Dust collector bags clogged 	<ul style="list-style-type: none"> Be sure to shake the dust bags well. Change bags as needed
	<ul style="list-style-type: none"> Wrong outlet gate valve adjustment at fan outlet 	<ul style="list-style-type: none"> Make sure the gate controlling the flow of exhaust air leaving the fan is properly set.
	<ul style="list-style-type: none"> Air leakage 	<ul style="list-style-type: none"> Make sure there are no leaks in pipes or hoses conveying abrasive. Make sure check of the seal between the pressure vessel and the cyclonic system.
The ventilation system works but sandblasting does not work.	<ul style="list-style-type: none"> Control of depressurization is to "OFF" position 	<ul style="list-style-type: none"> Reposition to "ON" position
	<ul style="list-style-type: none"> The security system of the doors is open. 	<ul style="list-style-type: none"> Make sure the doors connected to the system are all closed
	<ul style="list-style-type: none"> A problem related to control of the vessel pressure. 	<ul style="list-style-type: none"> Refer to the manual of the pressure vessel in the troubleshooting section
The abrasive is found in large quantities in the dust	<ul style="list-style-type: none"> Too much secondary air supply. 	<ul style="list-style-type: none"> Look for an air leak between the pressure vessel and the storage hopper or cyclone system Adjust the belt adjustment of the cyclonic system Adjust the gate valve on the fan air outlet
Significant amount of dust in the clean abrasive	<ul style="list-style-type: none"> Enough secondary air supply 	<ul style="list-style-type: none"> Adjust the belt adjustment cyclonic system

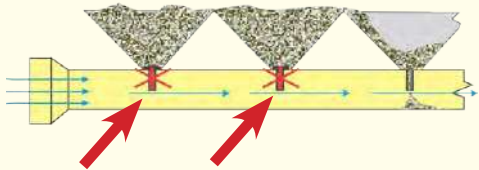
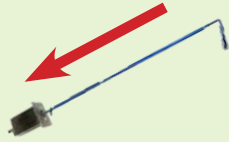
TROUBLESHOOTING (CONT'D)

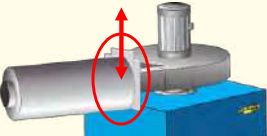
DEFECTS	CAUSES	REMEDIES
<p>Abrasive accumulates in the supply hoppers of the suction lines</p>	<p>One or more injectors are clogged</p> 	<p>Use the tool provided to force the abrasive through the injectors.</p> 
<p>Abrasive accumulates in the suction lines (especially in the vertical rise elbow).¹</p>	 <p>Cause 1 - Filters (bags or cartridges) are partially or completely blocked</p>	<p>Replace the filter media</p>
	 <p>Cause 2 - The dust barrel is full and the dust build-up rises to the bag level (baghouses only).</p>	<p>Empty the drum and the dust exhaust duct. Replace the bags if they have been damaged.</p>
	<p>Cause 3 - Improper adjustment of the exhaust hatch located at the outlet of the dust collector fan.</p> 	<p>The opening of the trap door is adjusted at the factory according to the abrasive mentioned at the time of purchase. It should only be adjusted when the abrasive is changed. Contact your IST representative for the correct adjustment for your application.</p>

¹ When abrasive builds up in the suction lines, it means that the airflow velocity in the suction lines is insufficient for your application. To validate if the suction velocity is sufficient, simply observe the ducts to see if the abrasive is being sucked in or use a pressure gauge to take a measurement under the nozzle located at the end of the duct (at the duct air inlet).

ABRASIVE MEDIA RECOVERY SYSTEM - CONFIGURATIONS

After contact with work pieces, abrasive media falls on the floor and mixes with the blasting process by-products – paint chips, rust, scale, shattered blast media, solid debris, etc.

The dirty media mix is sucked through a ducting vacuum system all the way to the cyclonic separator where particles are sorted out based on their specific density, through vortex separation.

FLOOR RECOVERY HOPPERS

Different configurations are available. Refer to your custom drawing provided by ISTblast.

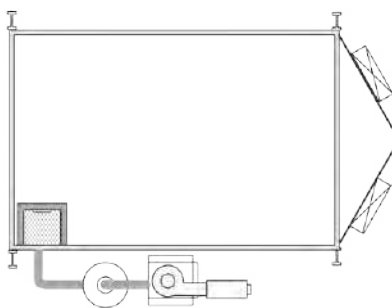

Corner shoot / Shoveling

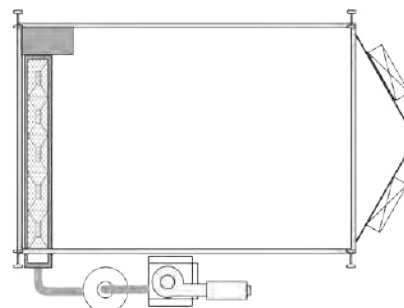

Single in ground pneumatic through

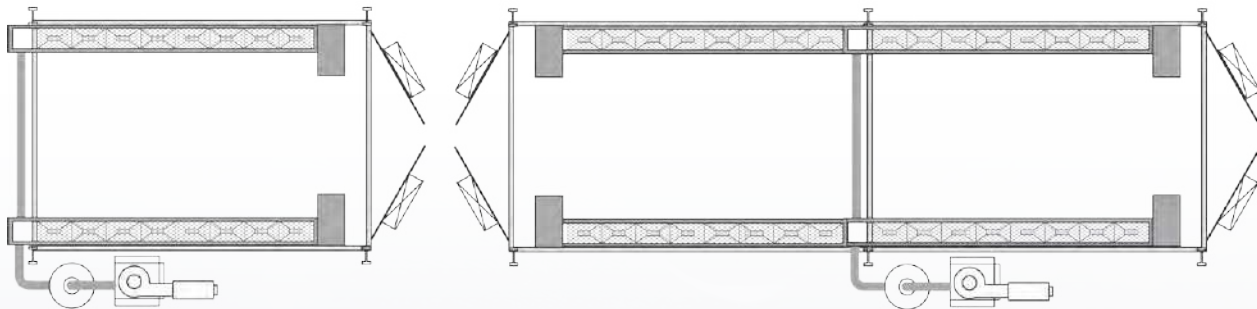

Double in ground pneumatic through

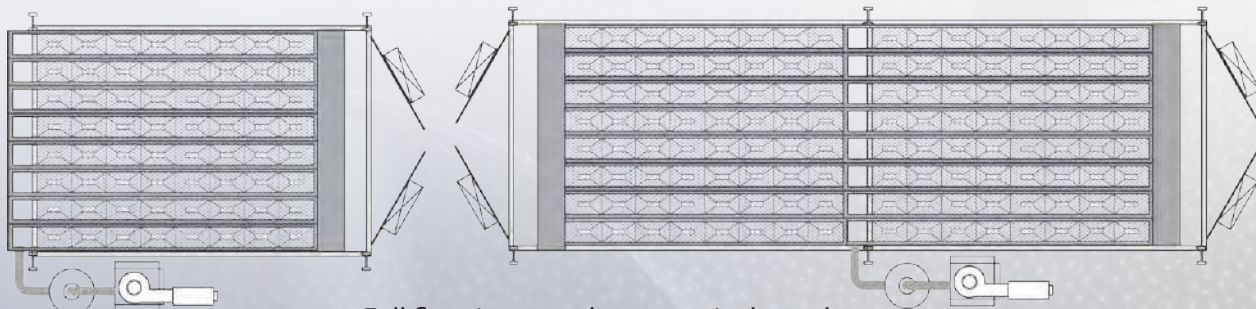

Full floor in ground pneumatic through

ABRASIVE MEDIA RECOVERY SYSTEM - CYCLONIC SEPARATION OF PARTICLES

A high-speed rotating motion is created when the airflow travels through the cylindrical-shaped housing of the cyclonic separator.

To avoid premature wear on panels caused by friction with the dirty media mix, an optional rubber lining can be added to protect the interior walls of the cyclonic separator.

When leaving the cyclonic separator, the dirty media mix has two possible exits:

1. **Light particles** – dust, paint chips, rust, scale, shattered media, etc. are drafted up and diverted to the dust collector.
2. **Heavier particles** – abrasive media still in good shape and large debris fall down through a mesh drawer where large debris is trapped, leaving only good reusable media to reach the blast pot for further blasting operations.

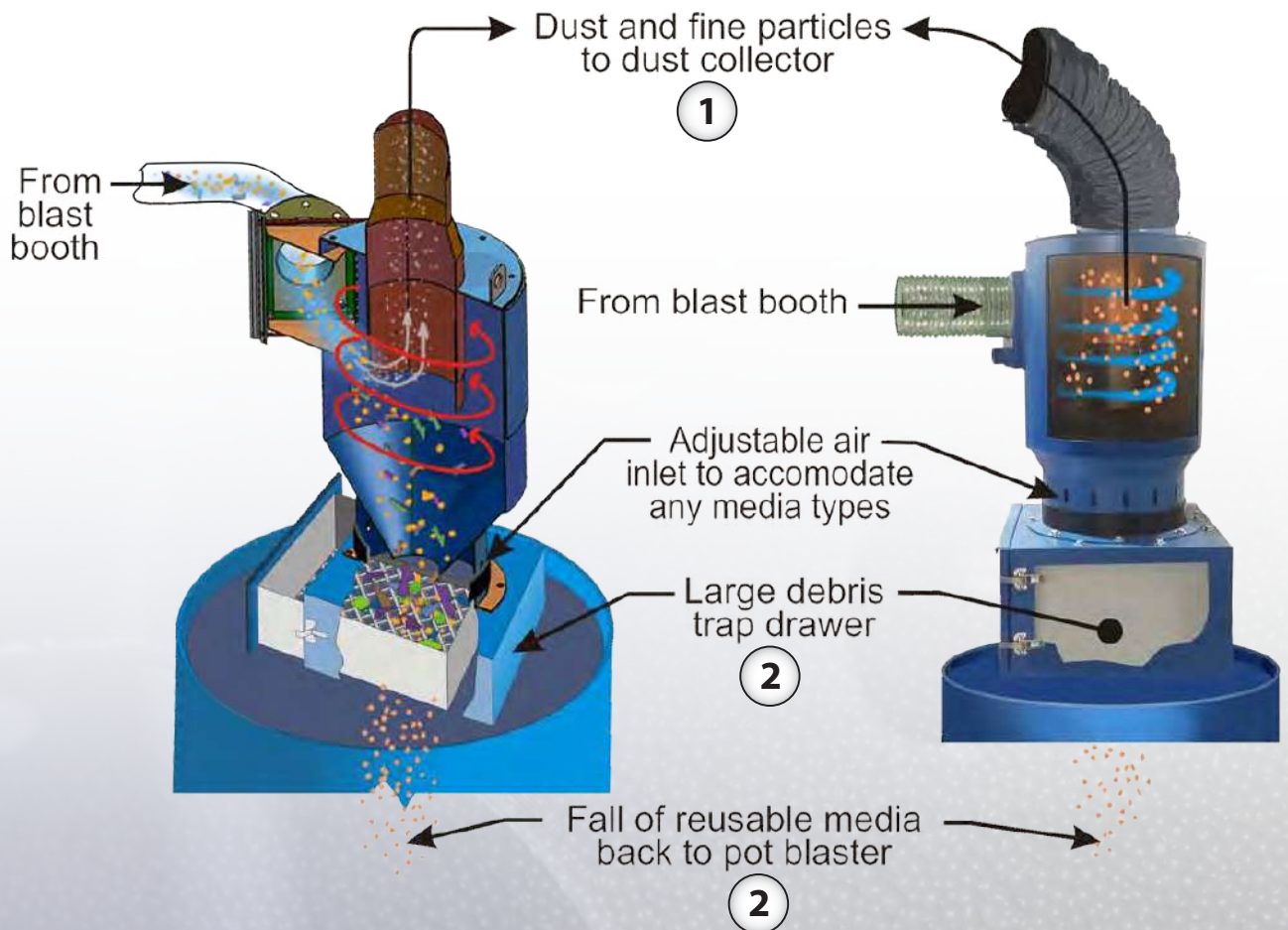

SB STARTING PROCEDURE - ADDING ABRASIVE & RECYCLER INFORMATION

ADDING ABRASIVE

Start the recovery system and pour abrasive media directly into the floor recovery pit and wait until it is completely emptied, and check the level again.



Optional abrasive level sensor detector

This option is installed in order to limit the amount of abrasive accumulated in the storage hopper. When the abrasive level reaches the abrasive level detector, the MRS200 recovery system shuts down automatically.

You must then stop filling the floor hopper and depressurise the pressure vessel to transfer abrasive from hopper to the pressure vessel.

RECYCLER INFORMATION

Although the recycler is factory set, it is possible to increase the amount of fine dust to be sucked up by the dust collector. There are two methods to change those settings:

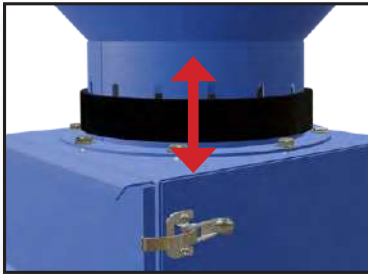

1. Adjustment of the SBR 1/8 " X 2 " rubber band

This adjustment will influence the quantity of dust that will be evacuated to the dust collector. Proceed step by step, moving down the rubber band 1/4" at the time, covering or uncovering the slots behind it. **A wider opening will draw up more dust to the dust collector; a smaller opening will reduce that quantity. The equipment has to run for approx. two (2) hours** before any changes can be noticed. Repeat as needed.

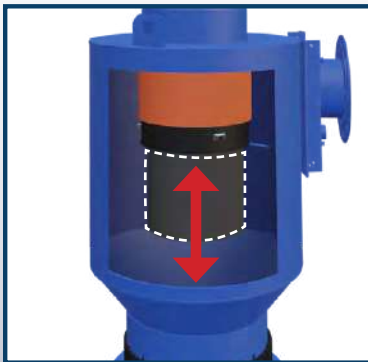

2. Adjustment of the telescopic tube, inside of recycler

If, after a few tests, the rubber band adjustments should prove to be insufficient, you will have to proceed to the telescopic tube adjustment. This will be necessary if you have to change the abrasive type or granulometry. Proceed step by step, moving the tube up or down, 1 inch at the time. **The equipment has to run for approx. two (2) hours** before any changes can be noticed. Repeat as needed. **Moving the tube downward will increase the quantity of dust** drawn up by the dust collector, **moving it up will decrease that quantity.**

HMI (HUMAN MACHINE INTERFACE)
FOR PNEUMATIC BLAST BOOTHS

HMI



MRS STARTING PROCEDURE

OPERATION IN AUTOMATIC MODE

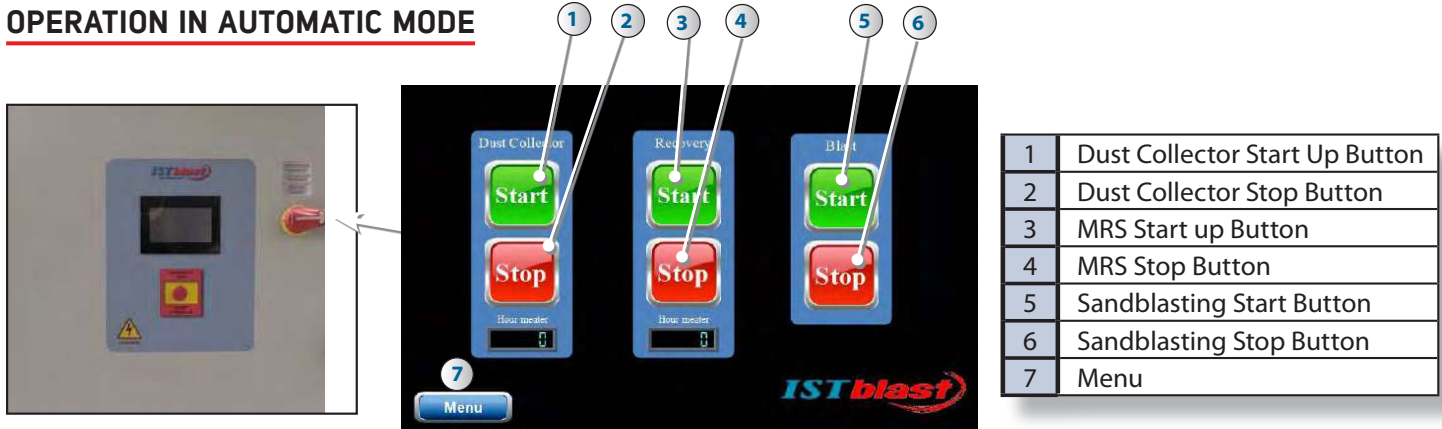

1. Turn on the sandblast room **"DUST COLLECTOR"**. ①
2. Start the **"RECOVERY SYSTEM"** ③ and pour the abrasive in the recovery pit and wait until it is completely emptied. Make sure that the level of abrasive in the pressure vessel is maximum : 2,000 pounds of steel grit, 800 pounds for aluminium oxide or glass bead. Check through the inspection window of storage hopper located above the vessel, you should see a slight accumulation above the cap* located above the upper opening of the vessel* (maximum 1 to 2 inches above) again.
3. Open the main air supply valve and adjust the air pressure at the inlet of pressure vessel to the desired blasting pressure.
4. Put on the operator's vented hood and take care to adjust the air flow (if required)

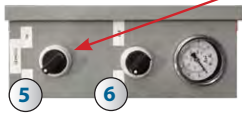

5. Pressurize the pressure vessel with the control unit by turning the switch to **"PRESSURIZED VESSEL"**. The vessel should pressurize at the blasting pressure already preset.
 6. Make sure to position the Blasting/Air Only switch to "Blasting"
- Note: If you have completed the installation of a security system on sandblast room doors, make sure that all doors are closed.

7. Turn **"ON"** the **"BLASTING"** ⑤
8. Hold blasting hose and nozzle firmly and activate the remote control lever.
9. The air and the abrasive will come out after the remote control lever has been pressed. Wait a few seconds in order for the stream to stabilise.
10. If the amount of abrasive seems insufficient or too important, please make an adjustment. Adjust the amount of abrasive to the nozzle by using the abrasive metering valve below the abrasive pressure vessel. Rotate clockwise to decrease the amount, and counterclockwise to increase (for reference, see manual pressure vessel PPB 346-646-1046). If necessary repeat again.
9. After a certain period of sandblasting, pressure vessel will be emptied of its contents, and the jet will consist solely of air. Release the trigger remote control to stop the jet.
11. Depressurize pressure vessel by switching the depressurising switch to **"DEPRESSURIZED VESSEL"** of the control box (see step 5)
12. If your sandblasting room floor has a pit partially covering it, it may be that the majority of the abrasive was sprayed on the floor next to the pit. Push all of the abrasive in the pit so that the recovery system can draw the abrasive towards the pressure vessel, and wait until all of the abrasive is transferred to the pressure vessel.

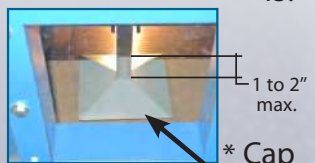

13. Make sure that the level of abrasive is at maximum in the pressure vessel. look through the inspection window of storage hopper located above the vessel, we should see a slight accumulation over the *cap located above the top opening of the vessel* (maximum 1 to 2 inches above).

FATEK HMI INTERFACE



SCREEN SAVER MODE

ISTblast screen saver will display after 4 minutes of inactivity.
When touching it anywhere, the menu will display again.



HMI (HUMAN MACHINE INTERFACE) - MAIN MENU



By pressing the "Menu" button (5), the buttons from 1 to 4 will appear above

1	AUTOMATIC: Access the Automatic Mode Operation Screen
2	ALARMS: Display all ongoing and fixed alarm notifications
3	MANUAL: Access the Manual Mode Operation Screen
4	PARAMETERS: access to Language and Timer adjustments (requires a password)
5	MENU: Access all available menus (1 to 4)

1 AUTOMATIC MODE



The system will automatically lock itself after one minute of inactivity.

HMI - (HUMAN MACHINE INTERFACE) - USER ACCESS

2 ALARM

Date	Trigger	Recovery	Message
20/08/06	09:08:35	09:13:33	Recovery System Time Out
20/08/06	09:08:35		!! FIRE !!
20/08/06	09:08:35		Hi Level Air Particles
20/08/06	09:08:35		Overload Longitudinal Screw #8
20/08/06	09:08:35		Overload Longitudinal Screw #7
20/08/06	09:08:35		Overload Longitudinal Screw #6
20/08/06	09:08:35		Overload Longitudinal Screw #5
20/08/06	09:08:35		Overload Longitudinal Screw #4
20/08/06	09:08:35		Overload Longitudinal Screw #3
20/08/06	09:08:35		Overload Longitudinal Screw #2
20/08/06	09:08:35		Overload Longitudinal Screw #1
20/08/06	09:08:35		Overload Cross Screw



- | | |
|---|--|
| 1 | Error messages in green have been resolved |
| 2 | Error messages in red are in progress |
| 3 | Use scroll bar to scroll the page up/down |
| 4 | Press "Alarm" again to reset all alarms (if required)* |
| 5 | Return to menu |

If any default occurs, a sentence in red *indicating the nature of the alarm will be displayed while scrolling at the top of the main screen. When the fault is resolved, the sentence will disappear and will be displayed in green in the history of the alarm panel.

3 MANUAL MODE



Press the grey button to activate a system. The case will turn green while the system starts. A message will display under the buttons: "Once you leave this page, all the equipment in manual operation will be stopped"

HMI (HUMAN MACHINE INTERFACE) ADMIN. ACCES

When a higher security level is required a login box will open to let the user enter a password.
Applicable to the following menu:

4 PARAMETERS

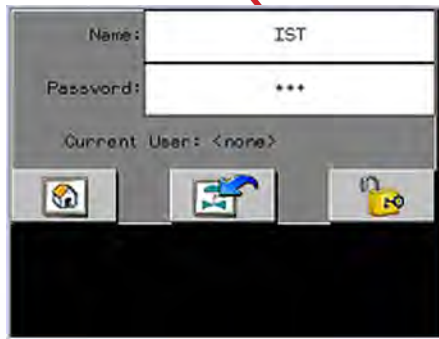
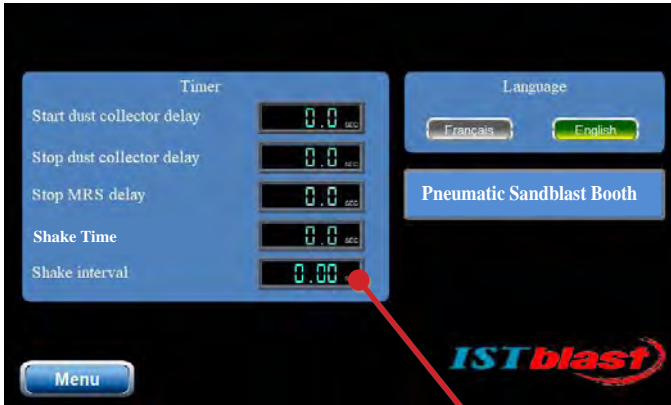

Enter your Name & Password

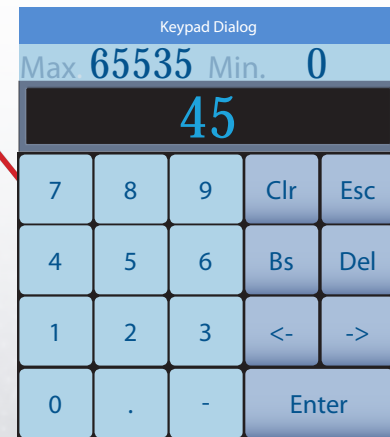

TOUCH ANY OF THESE CONTROL BOXES TO ADJUST VALUE BY USING THE POPUP KEYPAD

A worker wearing a full-body protective suit, including a green helmet with a clear face shield and blue gloves, is using a pneumatic tool in an industrial setting. The worker is positioned on the right side of the frame, facing left. The background shows a large window with a grid pattern and a white trash can. The floor is covered with a dark, textured material. The word "MAINTENANCE" is overlaid in large, bold, black capital letters across the center of the image.

MAINTENANCE

SANDBLAST BOOTH - PREVENTIVE MAINTENANCE SCHEDULE

BOOTH ENCLOSURE

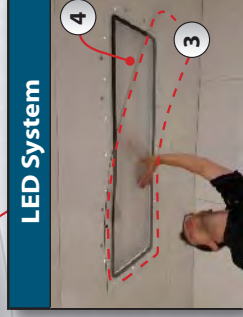
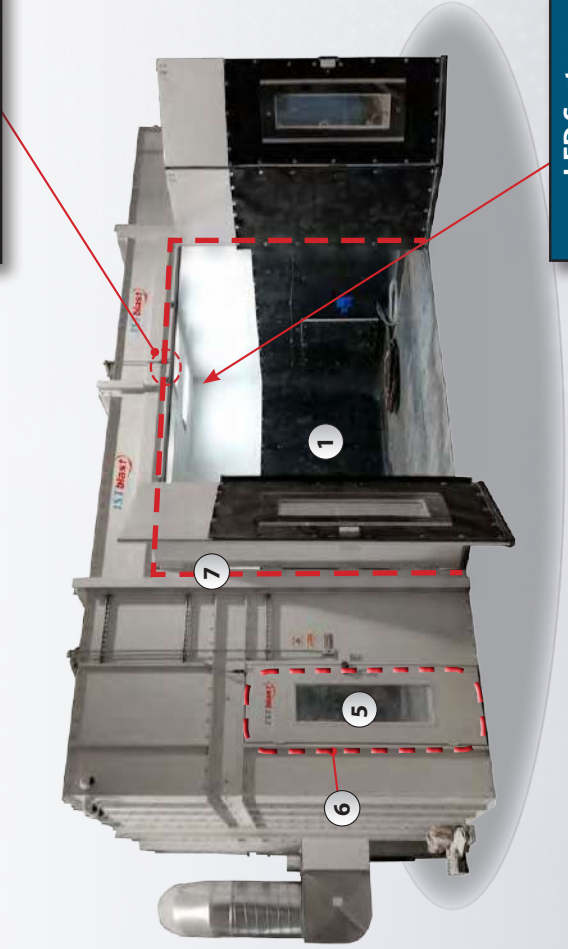

WEEKLY MAINTENANCE

- Rubber Lining ①:** Check for wear or deterioration of blast room rubber lining and replace when needed.
- Light System:** Clean frequently Light Lexan Cover ③ and replace when needed.
- Personal Men Door:** Clean frequently Door Lexan Window ④ and replace when needed. Make sure Door Seal ⑤ is airtight and replace when needed.

REPLACE WHEN NEEDED

DESCRIPTION	PART #
Rubber Lining (sold by square foot) ①	618330
Door Safety Switch ②	917586
Lexan Cover for Light ③	D900183S02
LED Light Fixture ④	617193
Lexan Door Window ⑤	613032
Door Seal ⑥ 1¾" x 5/8" (12.5 ft)	618438
Main Door Seal ⑦ 1¼" x 7/8" (45 ft)	618349

SANDBLASTING EQUIPMENT



DAILY MAINTENANCE & OPERATION

- Inspect Personal Protective Equipment (PPE) ①. Service or replace when needed.
- Arrange blast hose ⑤ in a way to avoid overlaps and steep curves.

WEEKLY MAINTENANCE

- Inspect and service remote control handle and hose ②.
- Inspect blast nozzle ③ and replace when needed.
- Inspect whip blast hose ④ for leaks and replace when needed.
- Inspect “whip” blast hose (the last section near the nozzle) ④ for leaks and replace when needed. The wall of the whip hose is thinner than other sections to facilitate handling, but it wears out faster.

MONTHLY MAINTENANCE

- Inspect blast hose ⑤, couplings ⑥ and gaskets for soft spots and premature wear. Replace when needed.
- Inspect breathing air supply hose ⑦, couplings and gaskets for soft spots and premature wear. Replace when needed.

REPLACE WHEN NEEDED

- Refer to Nozzle, Hose, and Coupling Selection Guide.

FLOOR RECOVERY HOPPERS

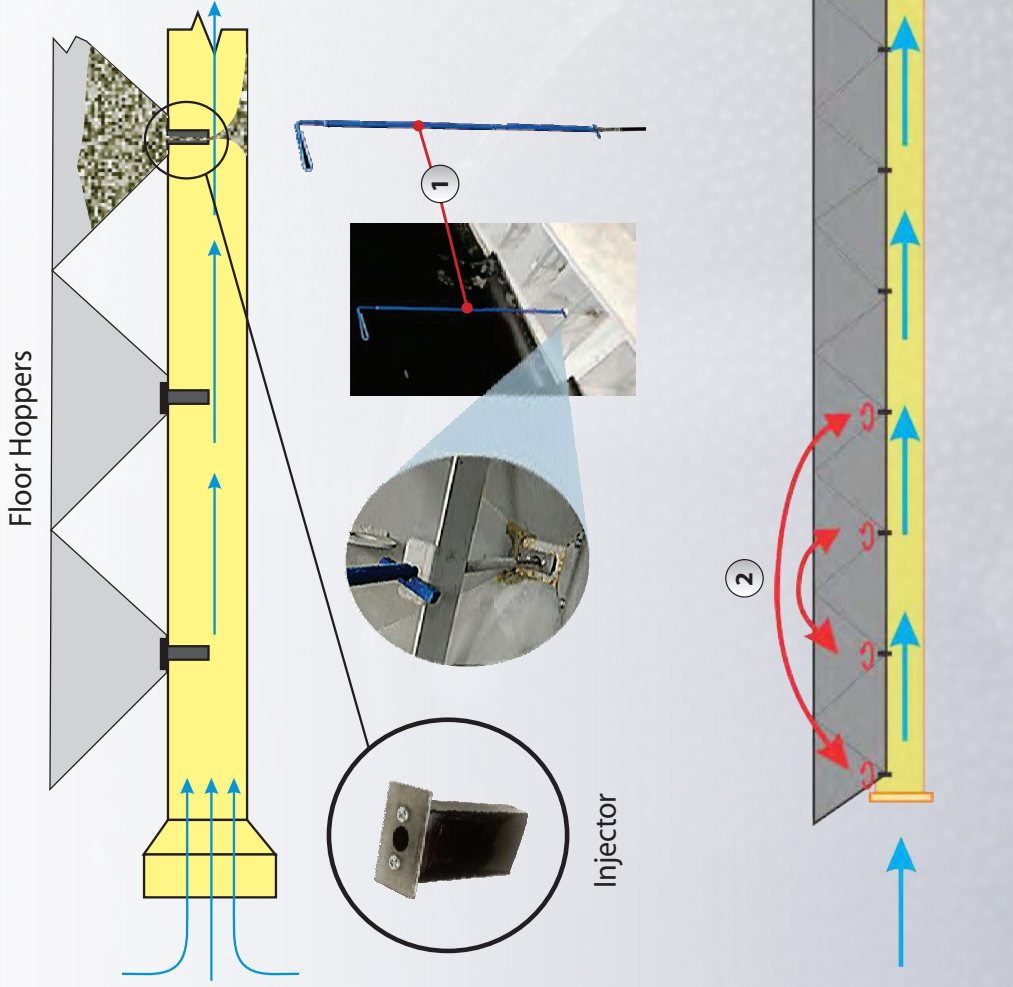

MEDIA CONVEY HOSES

- Unlog the injector with the unlogging tool 1
- The injectors are reversible and commutable : first /last as shown on the schematic 2
- Inspect media convey hoses and elbows 3

DCM200 DUST COLLECTOR PREVENTIVE MAINTENANCE SCHEDULE

WARNING

Bag media requires a light coating of dust to operate properly. **DO NOT SHAKE BAGS** during the first two weeks (approximately 60 hours) of operation to allow the creation of a fine dust layer on bags. For this reason, the new bags will leave a little dust escaping from the air outlet during the first hours of operation of your dust collector. If your dust collector is equipped with an automatic, pneumatic dust shaking option, **DO NOT CONNECT AIR SUPPLY** to the dust collector during that time.

DAILY MAINTENANCE & OPERATION

- 1 Once a day, at the end of the shift, **TURN OFF** the dust collector and shake bags by pressing on the pneumatic bag shaking button at least 10 times (skip if your dust collector is equipped with an automatic, pneumatic dust shaking option). **NEVER SHAKE BAGS** while the dust collector motor is running to avoid clogging the bags.
- 2 **Without waste drum option:** Place an container underneath the dust collector hopper and open the drain valve to empty the dust accumulation.
- 3 **Waste drum option:** Check and empty waste drum located underneath the dust collector.

WEEKLY/MONTHLY MAINTENANCE

BI-ANNUAL MAINTENANCE

- 4 Check the bearing of the motor and service or replace when needed.
- 5 Replace bag media when your dust collector is no longer able to efficiently exhaust the dust from the booth.
- 6 Check the sealing self-adhesive rubber foam and replace when needed.

NEVER WASH BAGS

You may clean bags using compressed air only by **BLOWING FROM THE OUTSIDE TO THE INSIDE** of bags (the opposite would clog the bag's pores and make it unusable). Watering the bags would torn them and make them unusable.

SPARE PARTS LIST

ID	PART #	DESCRIPTION	QTY
5	601316	DB6 Dust Bag Media	30
6	618306	1/2" x 1/2" self-adhesive rubber foam	12'

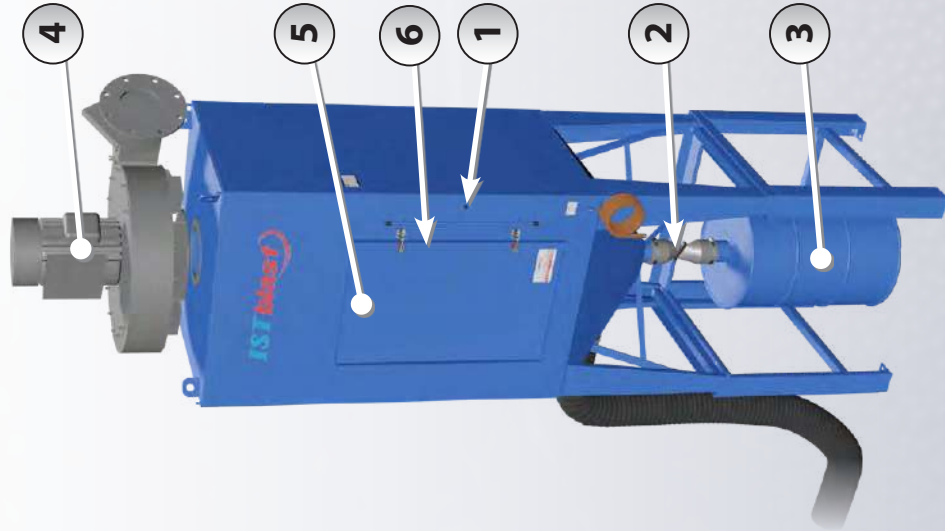

DB6 FILTER BAGS

DB6 Bag Filters are designed to maximize the performance of sandblasting equipment while minimizing the cost of maintenance and operation.



Their unique, seamless tube design consists of a patented “loop pile” surface that easily removes dust buildups during cleaning cycle, while preventing blinding or plugging of the fabric. Eliminating the seam also offers an additional filter area providing increased airflow.

Unlike conventional woven and needled textiles, the thickness and fiber density of the circular knit fabric provide a high permeability, reducing pressure drop conditions, with excellent filtration efficiencies. DB6 Bag filters can capture 99.5 to 99.9% of foreign particulates down to 4-6 microns.

They are made of circular knit polyester fabrics with addition of electrically conductive carbon fiber knitted into the fabric to protect against static build-up by constantly drawing off static charges to ground. Uncontrolled electrostatic build-up could lead to explosion or fire when combined with sufficient concentration of combustible dust floating in air. The anti-static yarn also plays a role in increasing filtration efficiency by avoiding static cling, due to opposing static charges between the dust and the filter bag, which prevent the bag from releasing the dust cake.

SPECIFICATIONS	
MATERIAL	100% POLYESTER
WEAVE	Knitted
YARN TYPE (WARP AND FILLING)	Texturized Filament
CARBON FIBER	Non shock carbon fiber yarn. The continuous carbon fiber yarn throughout the filter bag makes contact with the cell plate dissipating static.
MULLEN BURST	400 psi - 2758 kp
AIR PERMEABILITY	25 - 40 cu. ft./sq. ft. / min. (+ / - 5 cfm)
MAX OPERATING TEMPERATURE	290°F (143°C)
FILTRATION RATES	99.9 % of 4-6 µm

RECYCLER DETAIL

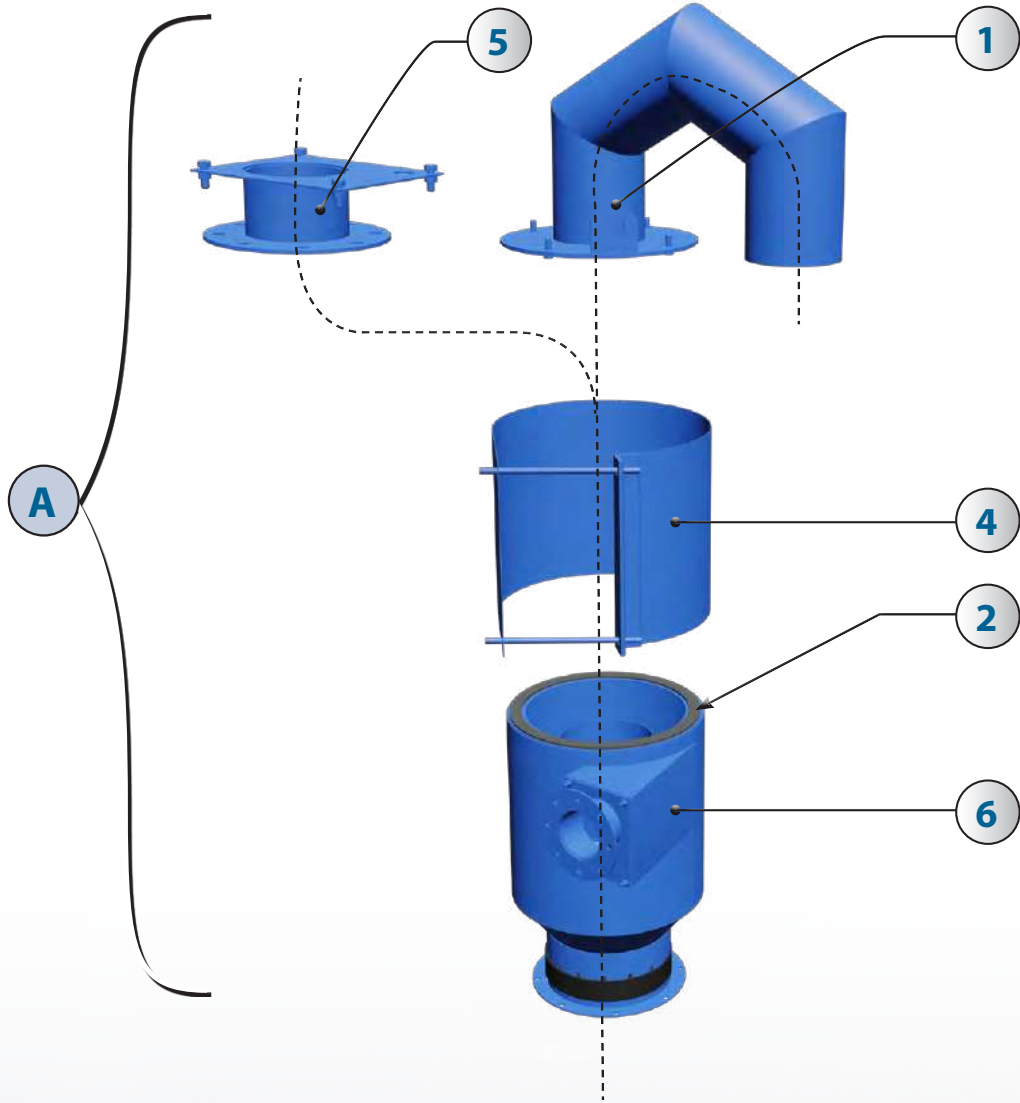

#	STOCK	DESCRIPTION
A	609233	COMPLETE RECYCLER
1	609217	20" OUTLET BOX
2	618318	SELF-ADHESIVE RUBBER (SOLD BY FOOT)
3	618334	RUBBER BAND (SOLD BY FOOT - 5.25')
4	618331	EXTERNAL REINFORCEMENT WEAR PAD
5	609233-C	INLET FLANGE
6	609233-A	20" BODY

UNITS - PARTS DETAILS

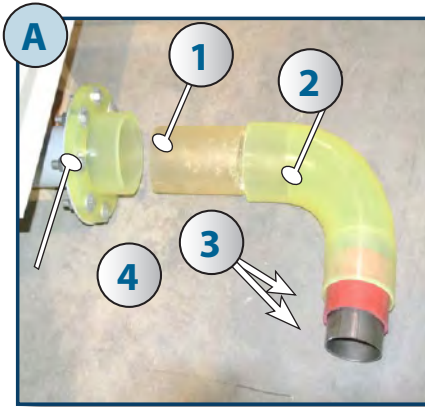

ELBOWS

#	STOCK	DESCRIPTION
A		COMPLETE ELBOW
1	940148	COUPLING SLEEVE (SOLD PER FOOT)
2	940140	4" ELBOW
3	601381	4" COUPLING SLEEVE (ASS'Y)
4	940144	CONNECTION ELBOW TO RECOVERY PIT

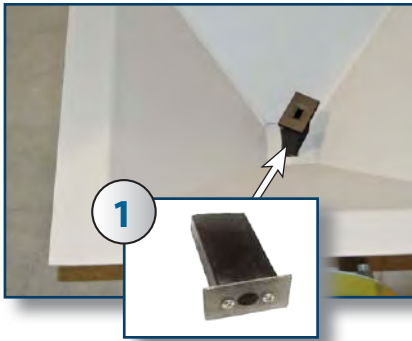

INJECTORS INTO RECOVERY PITS

#	STOCK	DESCRIPTION
1	600456	URETHANE INJECTOR 4" (RECOVERY PIT)
	600457	URETHANE INJECTOR 5" (RECOVERY PIT)
	600458	URETHANE INJECTOR 6" (RECOVERY PIT)
2	600541	INJECTOR CLEANING ROD (PIT 36")
	600543	INJECTOR CLEANING ROD (STD PIT)
3	NPN	HEX. BOLT 3/8"

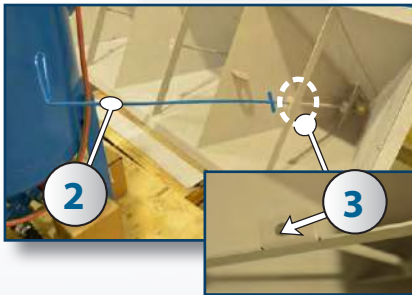

NB: The hex screws, 3/8" (3) must be placed in the holes as shown to prevent obstruction by the blast media and allow cleaning the injectors using the cleaning rod supplied (2).

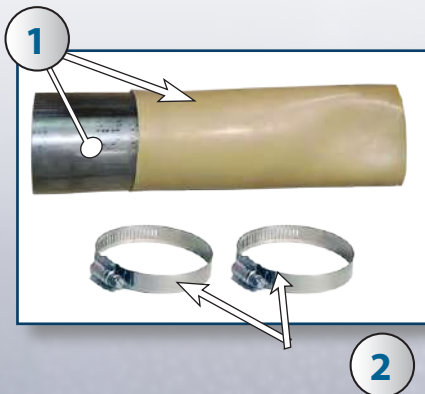

HOPPERS CONNECTIONS

#	STOCK	DESCRIPTION
1	600465	FLOOR HOPPER GASKET
2	624117	PIPE CLAMP

OPTION : SWITCH GATE FOR FLOOR HOPPER (PNEUMATIC)



ITEM NO.	QTY	DESCRIPTION	MAT'L
3	2	ANCHOR PLATE	3/16 PL
7	1	SLIDE PLATE	3/16 PL
54	2	1 1/2" X 1 1/2" X 1/4", 14" LG.	ANGLE UHMW
55	2	2" X 1", 14" LG.	UHMW
56	2	2" X 2" X 1/4", 15 27/32" LG.	ANGLE
201	2	URETHAN EL.BOV. 04" NDL.	940140
202	1	CYLINDER FOR BRACKET 908839	908839
203	1	CYLINDER 1 1/4" BORE, 6" STROKE	908839
204	2	THIN HEX. NUT 7/16-20	STEEL
205	1	FLEXIBLE HOSE 04"	606118
206	2	FLOW CONTROL	915574
207	8	WASHER 3/8"	NPN
208	12	NUT 3/8-16	NPN
209	1	URETHAN FLANGE 4" NDL.	940144
300	1	BASE SWITCH GATE	900564-A
301	1	FIXED PLATE ASSY	900564-B
302	1	SOLENOID VALVE 5 PORTS	606535

NOTE: THE VALVE MUST BE SUPPLIED SO THAT THE INDICATOR LIGHT IS VISIBLE

ELECTRICAL CDS. TO CONTROL PANEL

EXCLUSIVE RIGHTS

ISTBLAST INC. IS THE SOLE MANUFACTURER OF ALL PRODUCTS AND SERVICES PROVIDED BY ISTBLAST INC. IN CANADA AND THE UNITED STATES OF AMERICA. ALL RIGHTS ARE RESERVED BY ISTBLAST INC. FOR THE PRODUCTS AND SERVICES PROVIDED BY ISTBLAST INC. IN CANADA AND THE UNITED STATES OF AMERICA.

ISTBLAST INC. 346 Allée du Golf, St-Eustache (Québec) J7R 0M8 Canada
Tel: 1 800 361-1185 - 450 963-4400 Fax: 450 963-5122

DCM 200 DUST COLLECTOR: GENERAL PARTS DIAGRAM

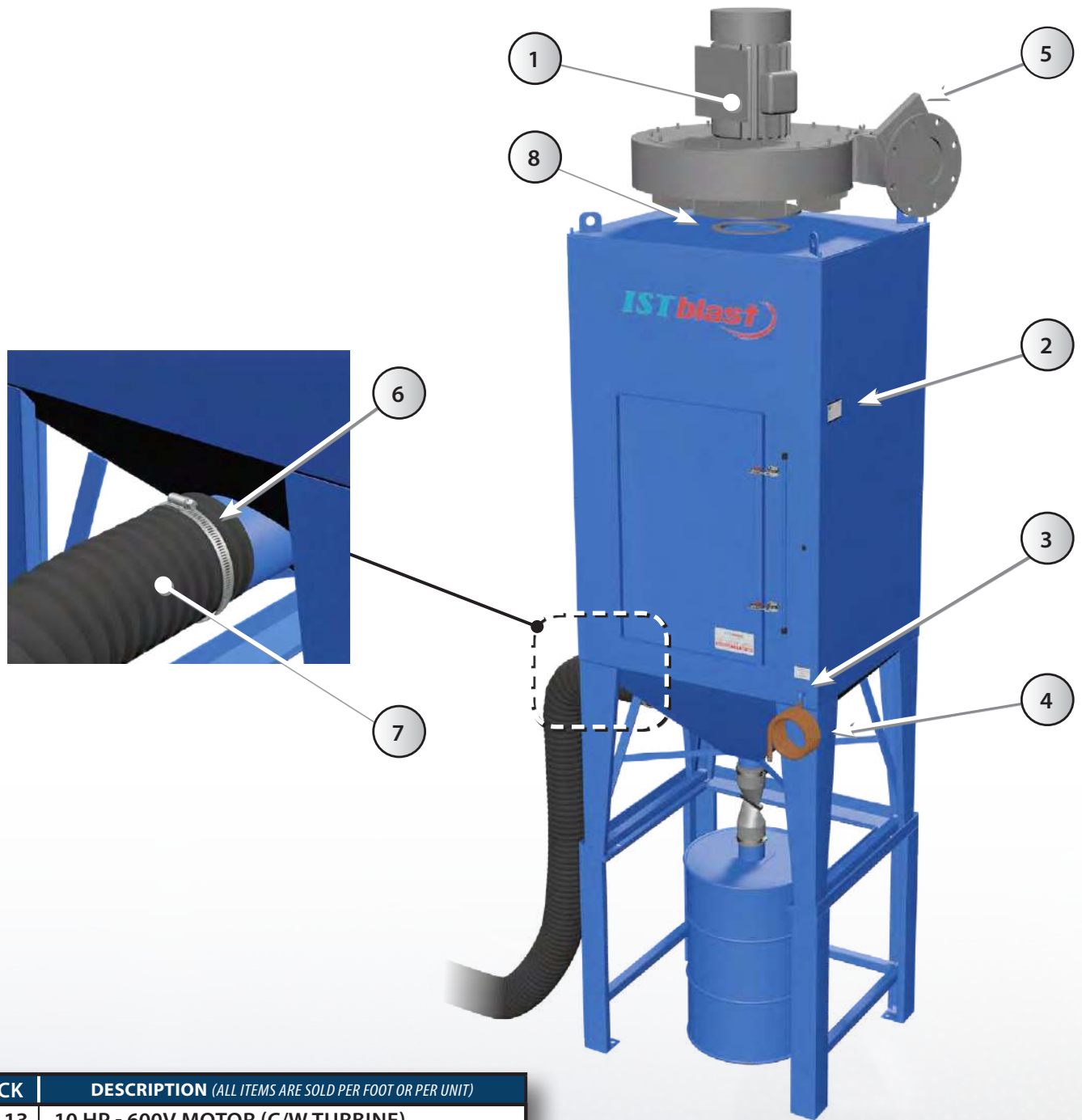

#	STOCK	DESCRIPTION (ALL ITEMS ARE SOLD PER FOOT OR PER UNIT)
1	916113	10 HP - 600V MOTOR (C/W TURBINE)
2	634240	NAME PLATE
3	607222	AIR INLET (1/4" MALE QUICK COUPLING)
4	600702	MULTIPUR HOSE KIT C/W 1/4" CONNECTOR
5	NPN	8" ADJUSTABLE AIR INLET
6	624128	CLAMPING RING
7	606173	8" Ø DUST CONVEYING HOSE, (SOLD PER FOOT)
8	618318	1/4" X 1/2" SELF-ADHESIVE RUBBER FOAM

RECOMMENDED SPARE PARTS

DESCRIPTION	PART NB
DB 6 bag (qty 30)	601316
Piston	608405

DCM 200 DUST COLLECTOR: INSIDE PARTS DIAGRAM

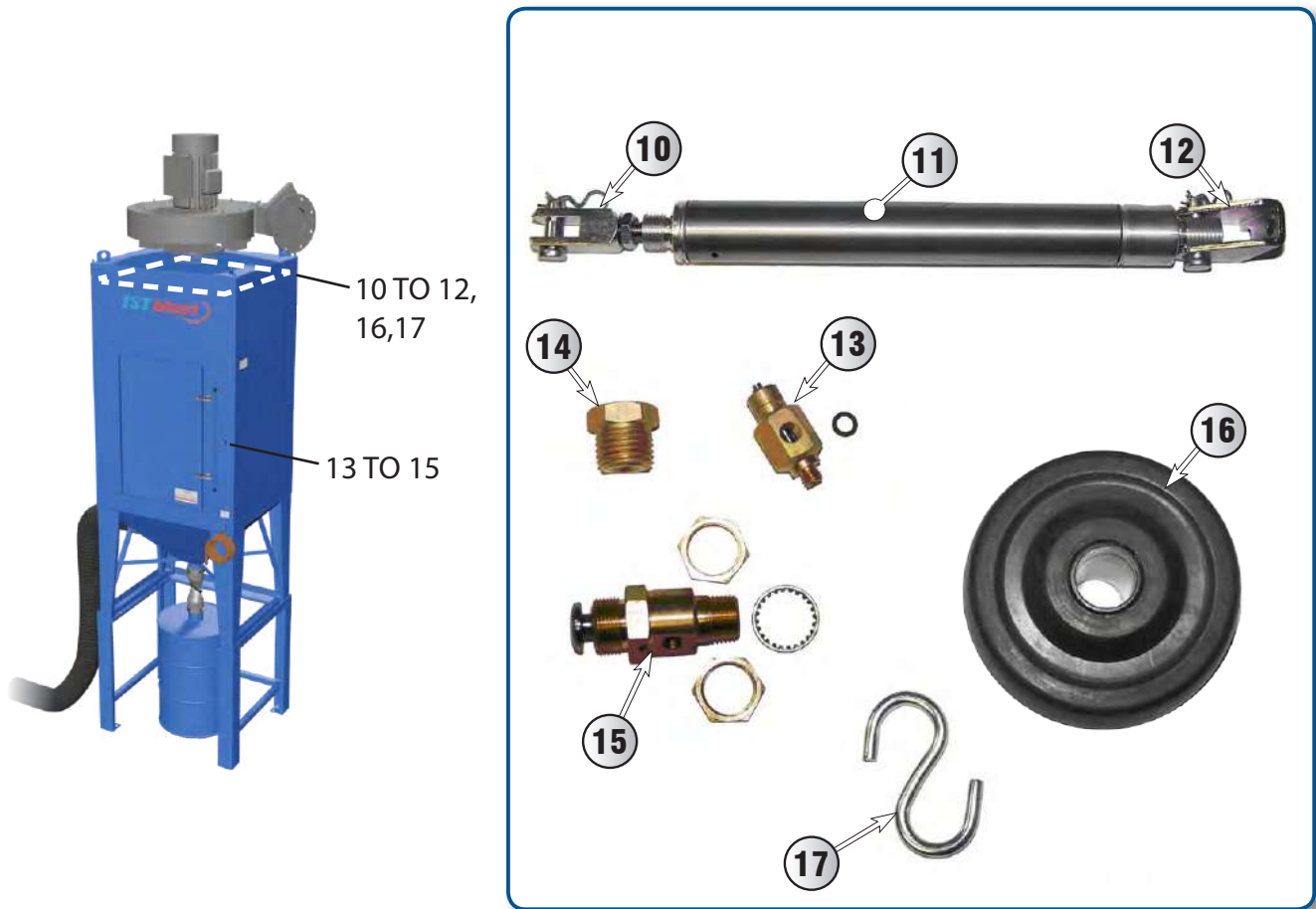

#	STOCK	DESCRIPTION (ALL ITEMS ARE SOLD PER FOOT OR PER UNIT)
10	608406	CLEVIS ROD SHAFT
11	608405	¾" DIA. X 3" STROKE CYLINDER
12	608407	BRACKET FOR CYLINDER
13	608408	FLOW ADJUST 10-32
14	608409	1/4" ADAPTOR
15	608508	PNEUMATIC SHAKER BUTTON
16	619005	2" WHEEL
17	601309	"S" HOOK



**SAFETY
EQUIPMENT**

AIR BREATHING – PROTECTIVE EQUIPMENT FOR THE OPERATOR

Abrasive blasting operators are equipped with Personal Protective Equipment (PPE) and respiratory equipment (RPE) to ensure the user is protected from materials and the respiratory health risks associated with a blasting environment. IST is an authorized distributor of RPB Safety providing the best respirators and supplied air breathing systems available on the market for blasters. All PPE and RPE has been designed to comply with the National Institute of Occupational Safety and Health standards (NIOSH).



BLASTING RESPIRATORS

RPB’s abrasive blasting line uses the latest available respiratory protection technology. The headtops are constructed with high-density polyethylene and manufactured in accordance with NIOSH certification. The respirators are equipped with a choice of six cape options that attach at the base of the headtop with its unique button and rubber seal design, ensuring no particulates enter the operators breathing zone. With multiple size options and adjustable padding system the headtop maintains a snug customizable fit that allows the respirator to move with the operator. With the headtop and breathing tubes weight evenly distributed across the head and shoulders this alleviates aches and strains on the user and reduces fatigue. All padding is machine washable for hygiene purposes.

The replaceable air inlet fitting is located at the back of the helmet in the center providing a streamlined airflow directing air to the breath zone and preventing the lens from fogging. All respirators feature a large visor window for uncompromised downward and peripheral vision and a set of replaceable tear off lenses for increased productivity. All parts are field replaceable and can be easily changed using the Allen key that sits neatly inside the padding.



Breathing air supply hose available in 25’, 50’, and 100’ lengths.



AVAILABLE WITH CHOICES OF CAPES

Nova 3

Nova 2000

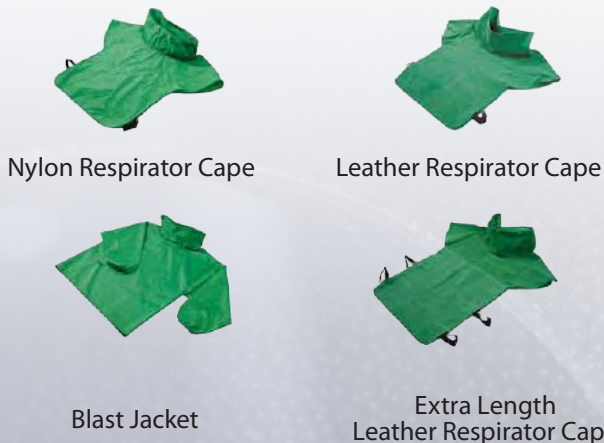

BLASTING RESPIRATORS ACCESSORIES

IST provides an extensive range of safety essentials and supplied air and respirator accessories from RPB to advance the safety of your team and increase productivity.

CLIMATE CONTROL DEVICES

The climate control devices can increase or decrease incoming air to control the temperature of supply air to the blaster for optimal comfort. Hot tube can increase incoming air by up to 20 °F /± 11 °C while Cold tube can drop the temperature by up to 32 °F/± 18 °C (evaluated at 20 cfm).

The C40 Climate Control Device combines both heating and cooling features to an even wider range – max increase is 32 °F/ ± 18 °C and max drop is 52 °F/± 29 °C – all by the press of a lever. The operator can also adjust the flow of cool and hot air to fall between this supply range.

All climate control devices are located on the fresh air tube unit, within the range of the operator.

Their performance may vary depending on the temperature of the incoming air. They all carry NIOSH approvals as part of the complete system and with the same approval numbers.



Compatible with Nova 3 respirator only

AUXILIARY HEAD LIGHT

The LED L4 Light provides up to 650 lumens of concentrated light to the operator's field of view for increased vision and safety while blasting. The L4 mounts directly to the Nova 3 and it is powered by a lightweight battery pack attached to the blaster's belt. The battery lasts for up to 6 hours with a recharge time of 3-4 hours.

INTEGRATED COMMUNICATION SYSTEM

The Nova Talk is a wireless radio communication system that fits securely inside the headtop allowing operators to communicate effortlessly with team members. The simplicity of the push to talk system ensures this does not get in the way of the operator's safety. The Nova Talk is ideal for working in remote locations, like tanks, shipyards or any other areas that are difficult to access.



AIR MONITORING, FILTRATION, AND SUPPLY

RPB's supplied air range covers air filtration and gas monitoring. These systems help protect the operator from contaminants in the air supply and notify them when there is harmful gas detected by their supplied air source. Air filtration and gas monitoring systems can help you towards achieving Grade D breathing air.

For Grade D breathing air, please refer to OSHA standard 29 CFR 1910.134 and consult an external provider for reliable air quality results. It is the end user's responsibility to comply with the standard.

BREATHING AIR LINE FILTER



2 outlet Radex - intended use of up to 1 operator and 1 gas monitor

6 outlet Radex - intended use of up to 3 operators and 1 gas monitor

The Radex is a robust and versatile airline filter with exceptional filtration capacity. It connects straight to the air line and it removes moisture, odor and particulates to 0.5 micron from the compressed air stream, providing clean, breathable air to the operator. Its replaceable filter cartridge exceeds industry filtration standards.



GAS MONITOR

The GX4 gas monitor detects when gases are present in the air supply source, alerting when carbon monoxide, oxygen and hydrogen sulphide are at levels above/below grade D breathing requirements. Its smart device and cloud integration capabilities allow you to view your air quality from any device in real time. The system stores and logs up to two years' worth of data.



OPTIONAL ACCESSORIES



Carry case for field protection



Wall Bracket



Audible and strobe light Alarm systems





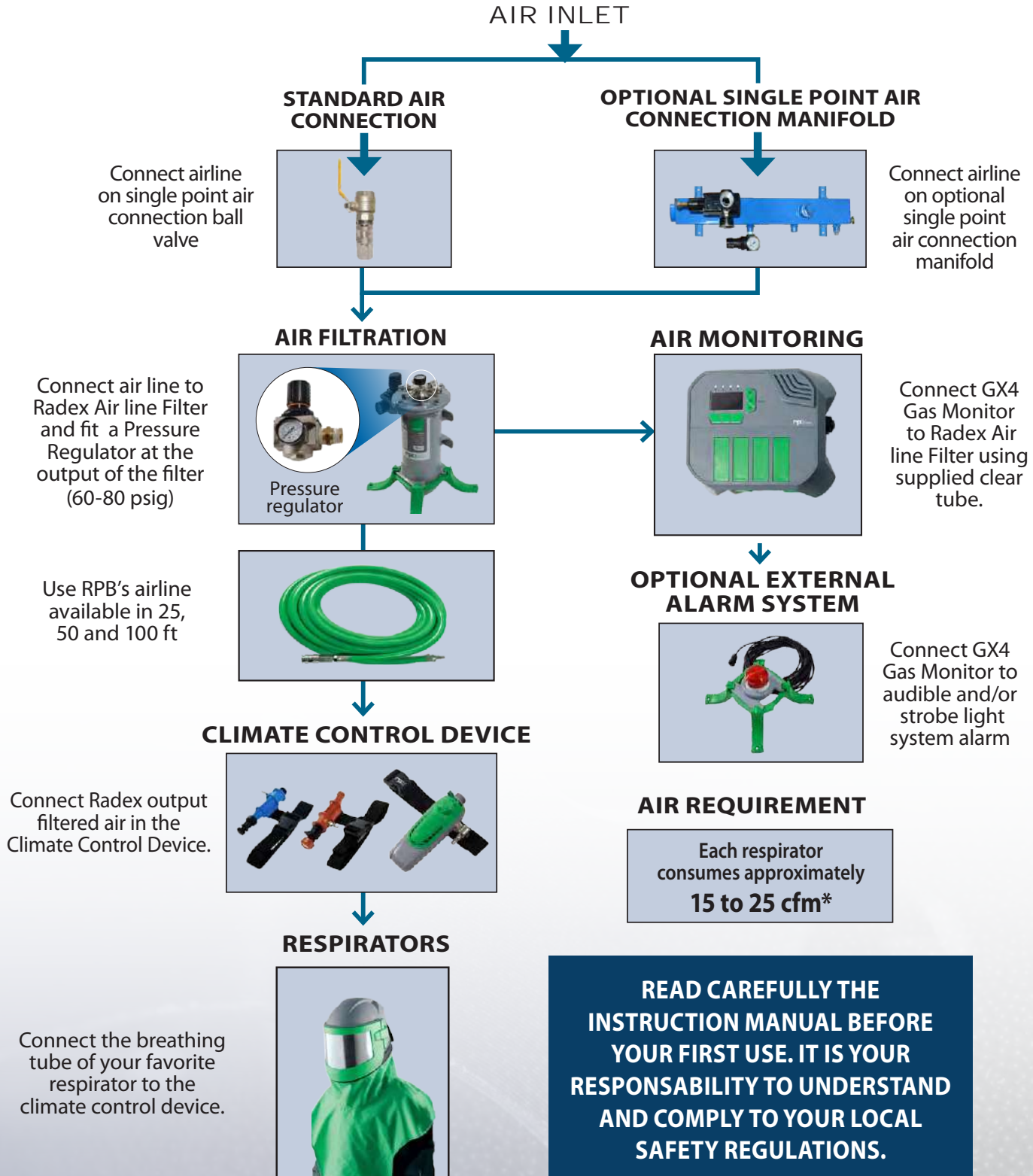



COMPLETE AIR BREATHING SYSTEM ASSEMBLY

The connection procedure below demonstrates how the RPB range helps to provide your operators with clean, safe breathing air that complies with NIOSH standards. All accessories are supplied with standard quick-connect fittings. Optional Schrader and RZ fittings are available upon request.



* Refer to Breathing Air Pressure Table in the instruction manual of your respirator. Air consumption may vary according factors like the climate, the flow device used and the total length of breathing air lines.

AIR FILTRATION AND MONITORING MAINTENANCE

EQUIPMENT	MAINTENANCE ROUTINE / FREQUENCY	SPARE PARTS
 Radex Air line Filter and gasket	<ul style="list-style-type: none"> ✓ Empty Drain Valve monthly* ✓ Replace Radex filter cartridges every 3 months or 400 working <p><i>*Not required if your Radex is equipped with Auto Drain Unit</i></p>	<div style="display: flex; justify-content: space-around;"> <div style="text-align: center;">  1 Replacement filter cartridge </div> <div style="text-align: center;">  2 Auto Drain Unit </div> </div> <div style="display: flex; justify-content: space-around; margin-top: 10px;"> <div style="text-align: center;">  3 Gasket </div> </div>
 GX4 Gas Monitor	<ul style="list-style-type: none"> ✓ Pre-calibrated GX4 gas sensors have a 2-year shelf life. ✓ Sensor check on each cartridge is required monthly using Calibration Flow Regulator and Gas bottles. 	<div style="display: flex; justify-content: space-around;"> <div style="text-align: center;">  4 Calibration Flow Regulator </div> <div style="text-align: center;">  5 Gas Sensors </div> </div> <div style="display: flex; justify-content: space-around; margin-top: 10px;"> <div style="text-align: center;">  6 Gas Bottles </div> <div style="text-align: center;">  7 Sensor Manifold Tube </div> </div>

PART #	STOCK	DESCRIPTION
1	APF3100	ORIGINAL RADEX FILTER CARTRIDGE
2	04-924	AUTO DRAIN UNIT
3	04-919	GASKET (PACK OF 2)
4	08-451	GX4 CALIBRATION FLOW REGULATOR FOR CO & ZERO AIR GAS BOTTLES (INCLUDES HOSE AND FITTING)
	08-452	GX4 CALIBRATION FLOW REGULATOR FOR H ₂ S GAS BOTTLES (INCLUDES HOSE AND FITTING)
5	08-420-01	GX4 GAS SENSOR CARTRIDGE CO 10 ppm
	08-420-02	GX4 GAS SENSOR CARTRIDGE CO 5 ppm
	08-420-03	GX4 GAS SENSOR CARTRIDGE H ₂ S 10 ppm
	08-420-04	GX4 GAS SENSOR CARTRIDGE OXYGEN 19.5-23 %
6	08-460	GX4 ZERO AIR (HAZMAT) FOR ZERO AIR AND OXYGEN SENSORS
	08-462	GX4 ZERO AIR (HAZMAT) FOR USE WITH H ₂ S 20 ppm CARTRIDGES
	08-461	GX4 CO 20 ppm (HAZMAT) FOR USE WITH BOTH 10 ppm AND 5 ppm CARTRIDGES
7	08-422	SENSOR MANIFOLD TUBE
	*NV2028	25' BREATHING AIR SUPPLY HOSE C/W CONNECTORS
	*NV2029	50' BREATHING AIR SUPPLY HOSE C/W CONNECTORS
	*NV2027	100' BREATHING AIR SUPPLY HOSE C/W CONNECTORS

*Air lines can be joined together up to 300' max overall length

FOR COMPLETE PARTS LISTING, DOWNLOAD RPB'S FULL PRODUCT CATALOG

BLAST SUITS

IST BLAST SUITS

IST offers a range of superior quality blast suits designed to produce the ultimate protection for workers, while increasing the comfort and productivity.

Available in ultralight nylon or durable leather, these suits are designed with only rugged materials and a combination of wear-resistant fabrics and porous cotton to keep the blaster dry and protected at all time.

The combinations include fastening straps to each cuff and to the bottom of the leg. A pair of heavy-duty leather gloves completes the set.



Ultralight Nylon



Heavy-Duty Leather

RPB BLAST SUIT

The RPB Blast Suit is a lightweight suit that provides protection against abrasive rebound.

It is made from heavy duty nylon to provide protection to the front of your body and arms, with a breathable cotton back to help keep you cool.

Features :

- ✓ Triple stitching for durability
- ✓ Optional knee pads
- ✓ Available in 7 sizes:
S, M, L, XL, XXL, XXXL, XXXXL
- ✓ Robust nylon zipper with protective cover
- ✓ Elasticated waist for a comfortable fit
- ✓ Elasticated wrists and adjustable ankle cuffs
- ✓ Interior pocket



Leather Gloves

ISTBLAST LIMITED WARRANTY

ISTblast warrants all equipment led in this manual which is manufactured by ISTblast and bearing its name, to be free from defects in material and workmanship on the date of sale by an authorized ISTblast distributor to the original purchaser for use. Notwithstanding any special, extended or limited warranty published by ISTblast will, for a period of TWELVE (12) months from the date of sale, repair or replace any part of the equipment determined by ISTblast to be defective. This warranty applies only when the equipment is installed, operated and maintained in accordance with ISTblast's written recommendations.

This warranty does not cover, and ISTblast shall not be liable for general wear and tear, or any malfunction, damage or wear caused by faulty installation, misapplication, abrasion, corrosion, inadequate or improper maintenance, negligence, accident, tampering, or substitution of non-ISTblast component parts. Nor shall ISTblast be liable for malfunction, damage or wear caused by the incompatibility with ISTblast equipment with structures, accessories, equipment or materials not supplied by ISTblast, or the improper design, manufacture, installation, operation or maintenance of structures, accessories, equipment or materials not supplied by ISTblast.

This warranty is conditioned upon the prepaid return of the equipment claimed to be defective to an authorized ISTblast distributor for verification of the claimed defect. If the claimed defect is verified, ISTblast will repair or replace free of charge any defective parts. The equipment will be returned to the original purchaser, transportation prepaid. If the inspection of the equipment does not disclose any defect in material or workmanship, repairs will be made at a reasonable charge, which charges may include the costs of parts, labor, and transportation.

THIS WARRANTY IS EXCLUSIVE, AND IS IN LIEU OF ANY OTHER WARRANTIES, EXPRESSED OR IMPLIED, INCLUDING BUT NOT LIMITED TO WARRANTY OF MERCHANTABILITY OR WARRANTY OF FITNESS FOR A PARTICULAR PURPOSE.

ISTblast's sole obligation and the buyer's sole remedy for any breach of warranty shall be as set forth above. The buyer agrees that no other remedy (including, but not limited to, incidental or consequential damages for lost profits, lost sales, injury to person or property, or any other incidental or consequential loss) shall be available. Any action for breach of warranty must be brought forward within one (1) year of the date of sale.

ISTblast MAKES NO WARRANTY, AND DISCLAIMS ALL IMPLIED WARRANTIES OF MERCHANTABILITY AND FITNESS FOR A PARTICULAR PURPOSE, IN CONNECTION WITH ACCESSORIES, EQUIPMENT, MATERIALS OR COMPONENTS SOLD BUT NOT MANUFACTURED BY ISTblast. These items sold, but not manufactured by ISTblast (such as electric motors, switches, hose, etc.), are subject to the warranty, if any, of their manufacturer. ISTblast will provide the purchaser with reasonable assistance in making any claim for breach of these warranties.

LIMITATION OF LIABILITY

In no event will ISTblast be liable for indirect, incidental, special or consequential damages resulting from ISTblast supplying equipment hereunder, or the furnishing, performance, or use of any products or other goods sold hereto, whether due to a breach of contract, breach of warranty, the negligence of ISTblast, or otherwise.

The following items are not covered under the ISTblast warranty policy:

- Parts or chassis replacement due to normal wears.
- Defective material or workmanship is not considered normal wear.

Report all accidents or "near misses" which involve ISTblast products to our service department :

1 877 629-8202

INFORMATION / TECHNICAL ASSISTANCE

ISTblast is a registered trademark of:



For more information, pricing or technical support, contact your local IST distributor or call / fax to our Consumer Information numbers:

TEL.: 1 877 629-8202 & 450 963-4400

Or visit us at:
istsurface.com

ABOUT THE COMPANY

WHO WE ARE

IST is a leading manufacturer of equipment for the surface treatment industry and the solvent recycling industry. Our extensive line of equipment includes batch units and automated machines designed to achieve the highest manufacturing standards.

MISSION

IST works tightly with their customers to transform industrial processes to improve their quality, productivity, and environmental footprint.

OUR SERVICES

- Custom Design & Fabrication
- Installation & Startup
- Preventative Maintenance Program
- Private Labels
- Testing Lab
- 24/7 Technical Support 5656

INDUSTRIES WE SERVE

- Aerospace & Aviation
- Aluminium Smelters
- Automotive
- Construction & Civil Engineering
- Flexography (labelling) & Lithography
- Foundry & Forge
- General Manufacturing
- Military
- Power & Energy
- Rail & Mass Transit
- Shipyards
- Wood finishing

